

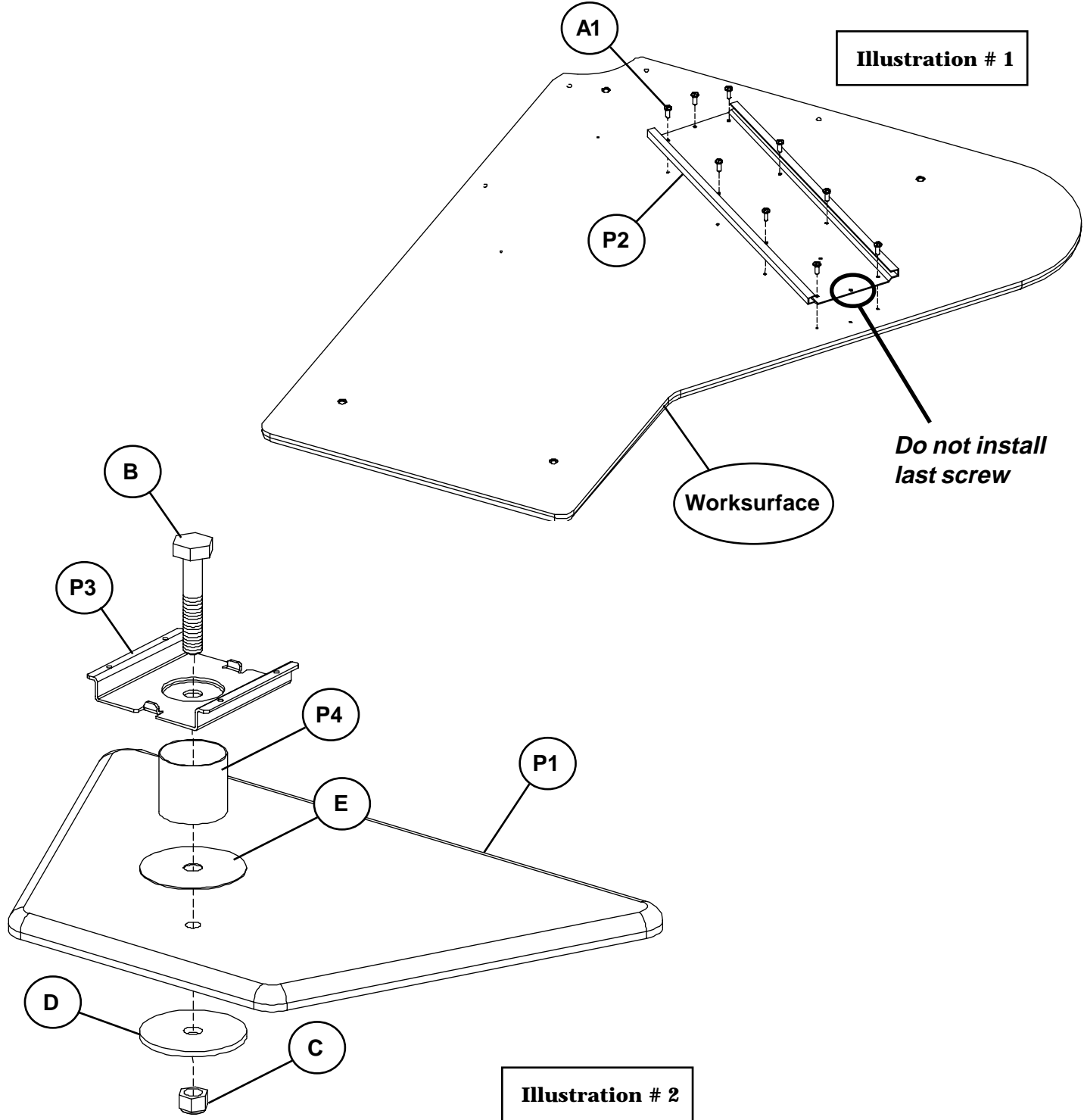

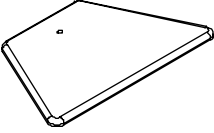

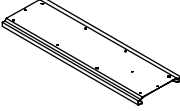

# KB-Swivel Assembly Diagram

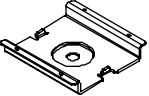
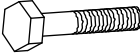

# KB-SWIVEL

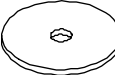
# Sliding Keyboard Platform

Part	Drawing	Description	Qty	Hardware List			
P1		Keyboard Platform	1 EA	Part	Drawing	Description	Qty
P2		Track	1 EA	A1		Wood Screw	10 EA
P3		Swivel Bracket	1 EA	B		Large Bolt	1 EA
P4		Metal Tube	1 EA	C		Lock Nut	1 EA
				D		Thick Washer	1 EA
				E		Thin Washer	1 EA

To Assemble:

1. Separate and Identify all the Parts and Hardware.
2. Place the Worksurface upside down. Attach Track (P2) using 9 each Wood Screws (A1) as shown in illustration #1. **(Do not install last screw in the Front-Center of Track)**
3. Attach Thin Washer (E), Thick Washer (D), Metal Tube (P4), and Swivel Bracket (P-3) to Keyboard Platform (P1) using 1 each Large Bolt (B) and 1 each Lock Nut (C).  
*See illustration #2.*

**(Be sure thin washer (E) is on top of Keyboard Platform, and Thick Washer (D) is under Keyboard Platform.)**

### Missing Parts or UPS Damaged Parts

For Your Convenience you can

EMAIL us at

[info@ergoindemand.com](mailto:info@ergoindemand.com)

24HOURS 7 DAYS A WEEK

**Should you require assistance during assembly,  
please call our Customer Service Department**

**Monday - Friday 8 a.m. - 4.30 p.m.**

**Pacific Time 1-800-888-6024**

Do not use unless all screws are tight. At least every six months, check all screws to be sure they are tight. If parts are missing, broken, damaged, or worn, stop use of the product until repairs are made by your dealer using factory authorized parts.

4. Slide Keyboard Assembly into Track (P2) as shown in illustration #3.

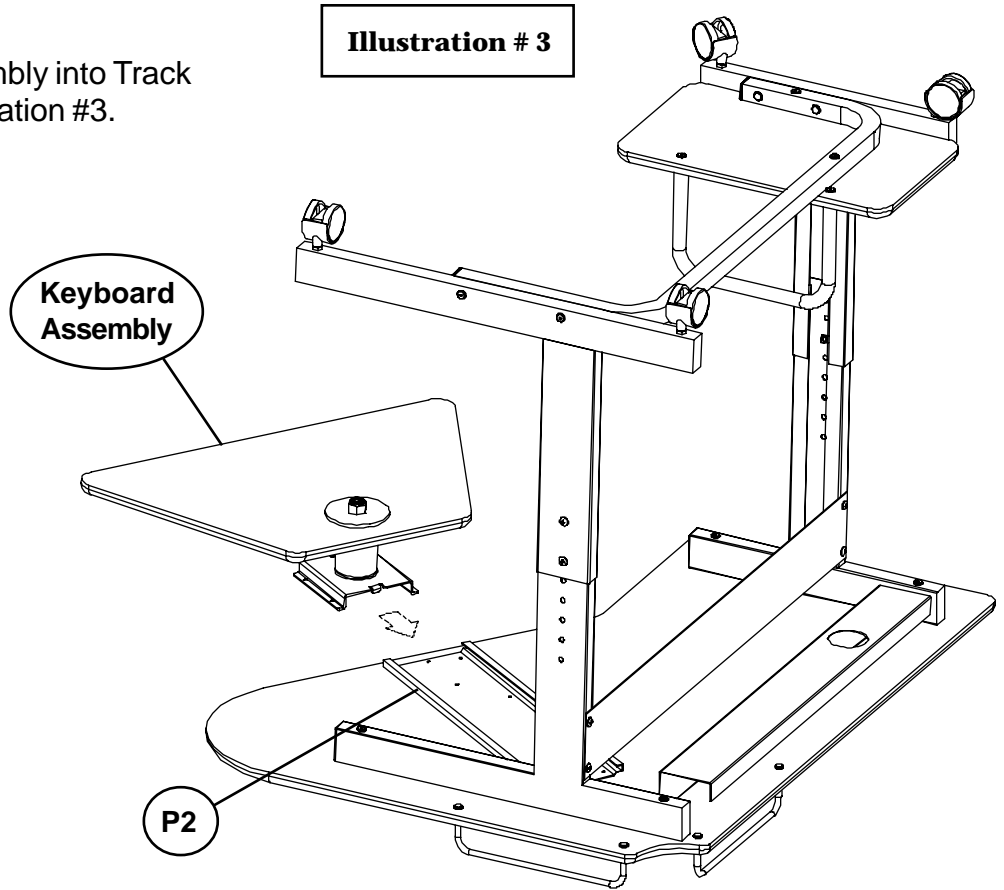

5. Install Wood Screw (A1) as shown in illustration #4 to prevent Keyboard Assembly from sliding out of Track (P2).

